



Air conditioner

User manual

AR**TSCA***

- Thank you for purchasing this Samsung air conditioner.
- Before operating this unit, please read this user manual carefully and retain it for future reference.



SAMSUNG

Contents

Safety Information	4
Safety Information	4
At a Glance	11
Indoor Unit Overview	11
Display	12
Remote Control Overview	13
Replacing the remote control batteries	13
Remote Control Operation	14
Selecting an operation mode	14
To set the temperature • To adjust the fan speed • To adjust the airflow direction	15
Smart Features	16
Power Smart Features	16
Wind-Free Cooling function	16
AI Auto mode	17
Auto mode • Cool mode	18
Dry mode • Fan mode	19
Heat mode • Automatic defrost	20
Variety Smart Features	21
Fast function	21
Motion detect function	22
Quiet function • Beep function	24
Display lighting function • Wi-Fi function (SmartThings app)	25
Energy-Saving Features	26
Electricity consumption check	26
Eco function	27
Timed on/ Timed off function	28
good'sleep function	29

Cleaning and Maintenance	30
Schedule	30
Cleaning	31
Appendix	37
Troubleshooting	37
SmartThings app	39



***Correct Disposal of This Product
(Waste Electrical & Electronic Equipment)***

(Applicable in countries with separate collection systems)

This marking on the product, accessories or literature indicates that the product and its electronic accessories (e.g. charger, headset, USB cable) should not be disposed of with other household waste at the end of their working life. To prevent possible harm to the environment or human health from uncontrolled waste disposal, please separate these items from other types of waste and recycle them responsibly to promote the sustainable reuse of material resources.

Household users should contact either the retailer where they purchased this product, or their local government office, for details of where and how they can take these items for environmentally safe recycling.

Business users should contact their supplier and check the terms and conditions of the purchase contract. This product and its electronic accessories should not be mixed with other commercial wastes for disposal.



Correct disposal of batteries in this product

This marking on the battery, manual or packaging indicates that the batteries in this product should not be disposed of with other household waste at the end of their working life. Where marked, the chemical symbols Hg, Cd or Pb indicate that the battery contains mercury, cadmium or lead above the reference levels in EC Directive 2006/66.

Safety Information



WARNING: Read This Manual

Read and follow all safety information and instructions before installation, use, or maintenance of this appliance. Incorrect installation, use, or maintenance of this appliance can result in death, serious injury, or property damage. Keep these instructions with this appliance. This manual is subject to change. For the latest version, visit www.samsung.com.

Because the instructions in this manual cover various models, the characteristics of your air conditioner may differ slightly from those described. If you have any questions, please contact your service provider or visit www.samsung.com.

Notices and notes

To make you aware of safety messages and highlighted information, we use the following notices and notes throughout this manual:



WARNING

Hazards or unsafe practices that may result in severe personal injury or death.



CAUTION

Hazards or unsafe practices that may result in minor personal injury or property damage.



IMPORTANT

Information of special interest



NOTE

Supplementary information that may be useful



The user and installer guides should be read carefully.



The user and installer guides should be read carefully.

FOR GENERAL

This appliance is not intended for use by persons (including children) with reduced physical, sensory or mental capabilities, or lack of experience and knowledge, unless they have been given supervision or instruction concerning use of the appliance by a person responsible for their safety. Children should be supervised to ensure that they do not play with the appliance.

FOR INSTALLATION



WARNING

Use a power cord with this product's power specifications or higher and use the power cord for this appliance only. In addition, do not use an extension cord.

- Extending the power cord may result in electric shock or fire.
- Do not use an electric transformer. This may result in electric shock or fire.
- If the voltage/frequency/rated current condition is different, it may cause fire.

The installation of this appliance must be performed by a qualified technician or service company.

- Failing to do so may result in electric shock, fire, explosion, problems with the product, or injury and may also void warranty on the installed product.

Install an Isolation Switch next to the Air Conditioner (but not on the panels of the Air Conditioner) and circuit breaker dedicated to the air conditioner.

- Failing to do so may result in electric shock or fire.

Safety Information

Fix the outdoor unit firmly so that the electric part of the outdoor unit is not exposed.

- Failing to do so may result in electric shock, fire, explosion, or problems with the product.

Do not install this appliance near a heater, or inflammable material. Do not install this appliance in a humid, oily or dusty location, in a location exposed to direct sunlight and water (or rain). Do not install this appliance in a location where gas may leak.

- This may result in electric shock or fire.

Never install the outdoor unit in a location such as on a high external wall where it could fall.

- If the outdoor unit falls, it may result in injury, death or property damage.

This appliance must be properly grounded. Do not ground the appliance to a gas pipe, plastic, water pipe, or telephone line.

- Failing to do so may result in electric shock, fire, and explosion.
- Make sure to use a socket-outlet with ground.



CAUTION

Install your appliance on a level and hard floor that can support its weight.

- Failing to do so may result in abnormal vibrations, noise, or problems with the product.

Install the drain hose properly so that water drains correctly.

- Failing to do so may result in water overflowing and property damage. Avoid adding drain to waste pipes as odours may arise in the future.

When installing the outdoor unit, make sure to connect the drain hose so that draining is performed correctly.

- The water generated during heating by the outdoor unit may overflow and result in property damage.
In particular, in winter, if a block of ice falls, it may result in injury, death or property damage.

Do not install the product in a place where thermo-hygrostat is needed (such as server room, machinery room, computer room, etc.)

- Those places do not provide guaranteed operation condition of the product therefore performance can be poor in these places.

FOR POWER SUPPLY



WARNING

When the circuit breaker is damaged, contact your nearest service centre.

Do not pull or excessively bend the power line. Do not twist or tie the power line. Do not hook the power line over a metal object, place a heavy object on the power line, insert the power line between objects, or push the power line into the space behind the appliance.

- This may result in electric shock or fire.

If the supply cord is damaged, it must be replaced by the manufacturer, its service agent or similarly qualified persons in order to avoid a hazard.



CAUTION

When not using the air conditioner for a long period of time or during a thunder/lightning storm, cut the power at the circuit breaker.

- Failing to do so may result in electric shock or fire.

FOR USING



WARNING

If the appliance is flooded, please contact your nearest service centre.

- Failing to do so may result in electric shock or fire.

If the appliance generates a strange noise, a burning smell or smoke, cut off the power supply immediately and contact the nearest service centre.

- Failing to do so may result in electric shock or fire.

In the event of a gas leak (such as propane gas, LP gas, etc.), ventilate immediately without touching the power line. Do not touch the appliance or power line.

- Do not use a ventilating fan.
- A spark may result in an explosion or fire.

Safety Information

To reinstall the air conditioner, please contact your nearest service centre.

- Failing to do so may result in problems with the product, water leakage, electric shock, or fire.
- Delivery service for the product is not provided. If you reinstall the product in another location, additional construction expenses and an installation fee will be charged.
- Especially, when you wish to install the product in an unusual location such as in an industrial area or near the seaside where it is exposed to salt in the air, please contact your nearest service centre.

Do not touch the circuit breaker with wet hands.

- This may result in electric shock.

Do not turn the air conditioner off with the circuit breaker while it is operating.

- Turning the air conditioner off and then on again with the circuit breaker may cause a spark and result in electric shock or fire.

After unpacking the air conditioner, keep all packaging materials well out of the reach of children, as packaging materials can be dangerous to children.

- If a child places a bag over its head, it may result in suffocation.

Do not touch the airflow blade with your hands or fingers during heating.

- This may result in electric shock or burns.

Do not insert your fingers or foreign substances into the air inlet/outlet of the air conditioner.

- Take special care that children do not injure themselves by inserting their fingers into the product.

Do not strike or pull the air conditioner with excessive force.

- This may result in fire, injury, or problems with the product.

Do not place an object near the outdoor unit that allows children to climb onto the machine.

- This may result in children seriously injuring themselves.

Do not use this air conditioner for long periods of time in badly ventilated locations or near infirm people.

- Since this may be dangerous due to a lack of oxygen, open a window at least once an hour.

If any foreign substance such as water has entered the appliance, cut off the power supply and contact the nearest service centre.

- Failing to do so may result in electric shock or fire.

Do not attempt to repair, disassemble, or modify the appliance yourself.

- Do not use any fuse (such as copper, steel wire, etc.) other than the standard fuse.
- Failing to do so may result in electric shock, fire, problems with the product, or injury.



CAUTION

Do not place objects or devices under the indoor unit.

- Water dripping from the indoor unit may result in fire or property damage.

Check that the installation frame of the outdoor unit is not broken at least once a year.

- Failing to do so may result in injury, death or property damage.

To prevent personal injury, make sure that you change the directions of the horizontal airflowblades after stopping the movements of the vertical airflowblade. (In case of adjusting the horizontal airflow manually)

Do not install the product in a ship or a vehicle (such as a campervan).

- Salt, vibration or other environmental factor may cause the product malfunction, electric shock or fire.

Do not stand on top of the appliance or place objects (such as laundry, lighted candles, lighted cigarettes, dishes, chemicals, metal objects, etc.) on the appliance.

- This may result in electric shock, fire, problems with the product, or injury.

Do not operate the appliance with wet hands.

- This may result in electric shock.

Do not spray volatile material such as insecticide onto the surface of the appliance.

- As well as being harmful to humans, it may also result in electric shock, fire or problems with the product.

Do not drink the water from the air conditioner.

- The water may be harmful to humans.

Do not hit, shake, drop, or attempt to disassemble the remote control.

When replacing the remote control batteries, keep them out of the reach of infants.

- If an infant eats batteries, contact a doctor immediately.

When replacing the remote control batteries, be careful not to get the battery fluid on your skin.

- Battery fluid is harmful to humans.



Safety Information

Do not touch the pipes connected with the product.

- This may result in burns or injury.

Do not use this air conditioner to preserve precision equipment, food, animals, plants or cosmetics, or for any other unusual purposes.

- This may result in property damage.

Avoid directly exposing humans, animals or plants to the airflow from the air conditioner for long periods of time.

- This may result in harm to humans, animals or plants.

FOR CLEANING



WARNING

Do not clean the appliance by spraying water directly onto it. Do not use benzene, thinner or alcohol to clean the appliance.

- This may result in discolouration, deformation, damage, electric shock or fire.

Before cleaning or performing maintenance, cut off the power supply and wait until the fan stops.

- Failing to do so may result in electric shock or fire.



CAUTION

Take care when cleaning the surface of the heat exchanger of the outdoor unit since it has sharp edges.

- This should be done by a qualified technician. Please contact your installer or service centre.

Do not clean the inside of the air conditioner by yourself.

- For cleaning inside the appliance, contact your nearest service centre.
- When cleaning the filter, refer to the descriptions in the 'Cleaning' section.
- Failing to do so may result in damage, electric shock or fire.
- Make sure to prevent any injury from sharp edges of the surface when handling the heat exchanger.



Indoor Unit Overview

The appearance of the actual product may differ slightly from the image below.

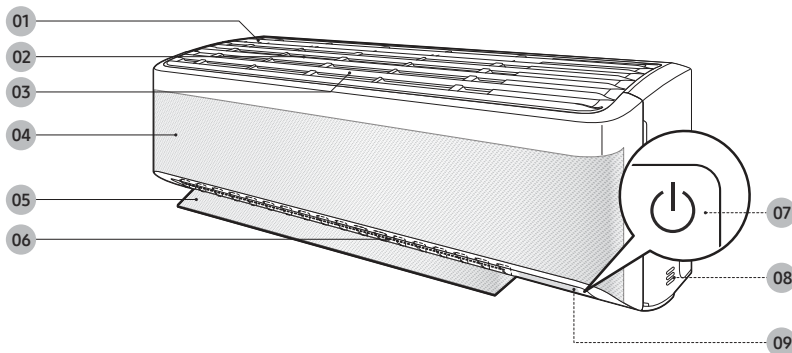

- 01 Air intake
- 02 Air filter
- 03 Tri-care filter
- 04 Wind-Free panel
- 05 Airflow blade (up and down)

- 06 Airflow blade (left and right)
- 07 Power button/Remote control receiver
- 08 Room temperature sensor
- 09 Display

NOTE

- The product ships with two Tri-care filters and the manual included.

Indoor Unit Overview

Display

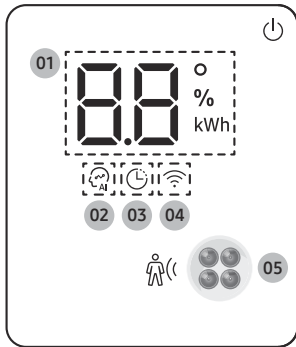

- 01 Temperature indicator (numeric)
Filter reset indicator (F)
Electricity consumption indicator (numeric)
Auto clean indicator (C)
Defrost indicator (dF)
- 02 AI Auto indicator
- 03 Timer indicator
good'sleep indicator
- 04 Wi-Fi indicator
- 05 Motion detect sensor

NOTE

- If the Wi-Fi indicator blinks for 10 seconds when operation starts, it means that the air conditioner is not connected to Wi-Fi. See "SmartThings app" on page 39 and connect the air conditioner to Wi-Fi.
- When connected to Wi-Fi, the air conditioner can gather and learn your user patterns so that it can run in AI Auto mode.

Remote Control Overview

Most operating instructions in this manual require using the remote control.

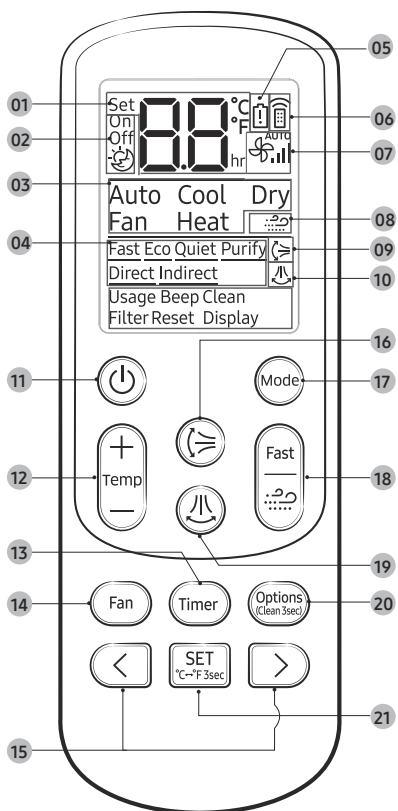

- 01 Set temperature indicator
- 02 Timer option indicator
- 03 Operation mode indicator
- 04 Options indicator
- 05 Low battery indicator
- 06 Transmit indicator
- 07 Fan speed indicator
- 08 Wind-Free indicator
- 09 Vertical air swing indicator
- 10 Horizontal air swing indicator
- 11 Power button
- 12 Temperature button
- 13 Timer button
- 14 Fan speed button
- 15 Direction button/Selection button
- 16 Vertical air swing button
- 17 Mode button
- 18 Fast/Wind-Free button
- 19 Horizontal air swing button
- 20 Options/Clean button
- 21 SET button/Temperature type button(°C↔°F)

NOTE

- Although **Purify** appear on the remote control display, they are not available on this model.

Replacing the remote control batteries

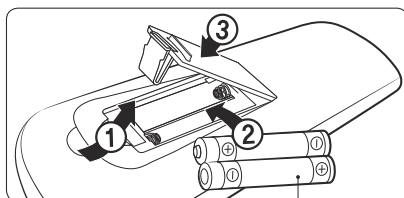

Two 1.5V AAA batteries

At a Glance

Remote Control Operation

You can use the air conditioner easily by selecting a mode and then by controlling the temperature, fan speed, and air direction.

At a Glance



Selecting an operation mode

To change the current mode between Auto, Cool, Dry, Fan, and Heat, press the (Mode) button.

You can use AI Auto mode after Wi-Fi is connected.

NOTE

You can use the Cool, Dry, and Heat modes in the following operation range.

Mode	Cool	Dry	Heat
Indoor temperature	16 °C to 32 °C	18 °C to 32 °C	27 °C or less
Outdoor temperature	-10 °C to 46 °C	-10 °C to 46 °C	-15 °C to 24 °C ¹⁾
Indoor humidity	Relative humidity of 80 % or less ²⁾	-	-

¹⁾ If the outdoor temperature drops to -15 °C, the heating capacity may decrease by as much as 60-70 %.

²⁾ If the air conditioner operates in Cool mode in a high-humidity environment for an extended period of time, condensation may occur.

You can switch between Celsius and Fahrenheit indications on the remote control.

► Press and hold for 3 or more seconds.

NOTE

- The temperature indications on the indoor unit are not switched.
- This function is canceled when the remote control batteries are replaced. In this case, run this function again.









To set the temperature

To control the temperature in each mode, press the  (Temperature) button:

Mode	Temperature control
AI Auto/Auto/ Cool/Heat	Adjust by 1 °C from 16 °C to 30 °C.
Dry	Adjust by 1 °C from 18 °C to 30 °C.
Fan	No temperature control.

To adjust the fan speed

Select from the following fan speeds in each mode:

Mode	Available fan speeds
AI Auto/Auto/ Dry	 (Auto)
Cool/Fan/Heat	 (Auto),  (Low),  (Med),  (High),  (Turbo)

To adjust the airflow direction

Keep the airflow in a constant direction by stopping the movements of the vertical and horizontal airflow blades.

In operation ►  or 

NOTE

- If you adjust the vertical airflow blade manually, it may not close completely when you turn off the air conditioner.
- Always use the remote control to adjust the airflow blades. Do not move the blades by hand. They may not operate normally.
- You cannot control the vertical airflow direction in Cool mode when the good'sleep function is on.

Power Smart Features

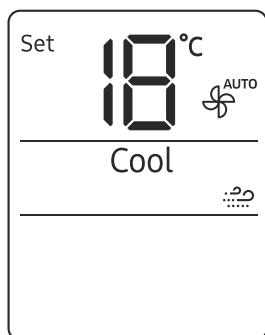



Wind-Free Cooling function

Use the Wind-Free Cooling function to enjoy a mild breeze coming through fine holes in the Wind-Free panel instead of air coming directly through the airflow blades.

In Cool/Dry/Fan mode ▶ 

NOTE

- To cancel this function, press the  (Wind-Free) button again.
- When the Wind-Free Cooling function is on, the air conditioner automatically controls the temperature and fan speed to keep your room mild and comfortable.
- When the Wind-Free Cooling function is canceled, the air conditioner returns to the original fan speed and air comes out of the airflow blades.
- In Cool mode, the recommended set temperature during the Wind-Free Cooling operation is 24 °C to 26 °C.
- You can use the Wind-Free Cooling function in Cool, Dry, or Fan mode.
- You cannot select the Quiet function during the Wind-Free Cooling operation.
- Selecting the Wind-Free Cooling function cancels the Fast, Eco, and airflow direction (, ) functions.

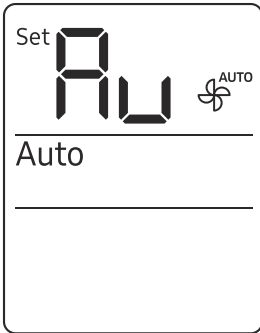



AI Auto mode

Use AI Auto mode to automatically operate any of Cool, Dry, Heat, and Wind-Free Cooling modes depending on the learned user patterns gathered from an external server via Wi-Fi module. The favourite temperature and operation mode are also set based on the current temperatures (indoor/outdoor) and the gathered user patterns.

 ►  ► Select Auto.

NOTE

- You can use this mode after Wi-Fi is connected. Otherwise, Auto mode is activated.
- In AI Auto mode, the  (AI Auto) and  (Wi-Fi) indicators appears on the display of the indoor unit.
- If the gathered user patterns are not sufficient, the set temperature is set to 24 °C.
- The set temperature is controlled within the range of 22 °C to 26 °C in AI Auto mode. You can also change it manually.
- When you press  (Mode) in AI Auto mode, the mode is cancelled.
- If you change the set temperature in AI Auto mode, it automatically changes back to the AI comfort temperature after 1 hour.

Power Smart Features

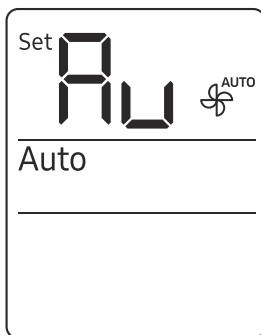

Auto mode

Use Auto mode to perform the powerful cooling or heating function to automatically reach the desired temperature. When the difference between the room temperature and the set temperature decreases, the air conditioner controls the fan speed and airflow direction.



NOTE

- If Wi-Fi cannot be connected or the Wi-Fi function is not supported, this Auto mode is automatically activated instead of AI Auto mode.
- When the room temperature is higher than the set temperature, the air conditioner automatically produces cool air.
- When the room temperature is lower than the set temperature, the air conditioner automatically produces warm air.

Cool mode

Use Cool mode to stay cool in hot weather.



NOTE

- For comfort, keep the temperature difference between the indoor and outdoor air within 5 °C.
- After selecting Cool mode, select the desired function, temperature, and fan speed.
 - To cool more quickly, select a lower temperature and a faster fan speed.
 - To save energy, select a higher temperature and a slower fan speed.
 - As the room temperature nears the set temperature, the compressor motor will slow down to save energy.

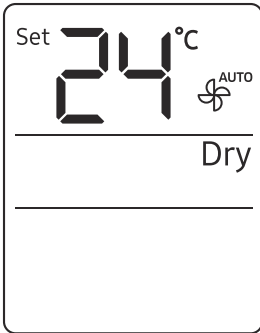

Dry mode

Use Dry mode in rainy or humid weather.



NOTE

- The proper set temperature range for dehumidifying operation is 24 to 26 °C. If you feel that the current humidity seems high, use a lower set temperature.
- You cannot use Dry mode for heating. Dry mode is designed to produce a cooling side-effect.

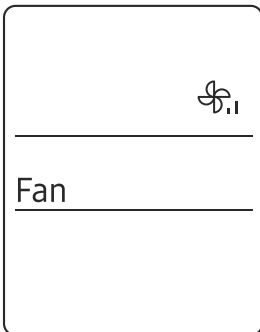

Fan mode

Use Fan mode to run the air conditioner like a floor fan, providing a breeze without heating or cooling.



NOTE

- If the air conditioner will not be used for an extended period of time, run it in Fan mode for 3 to 4 hours to dry the internal components.
- The outdoor unit does not operate in Fan mode. This is normal and not a fault with the air conditioner.

Power Smart Features

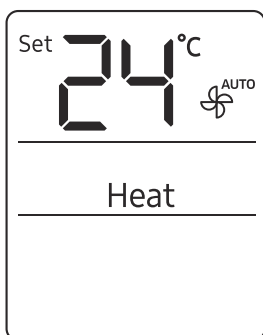

Heat mode

Use Heat mode to stay warm.



NOTE

- While the air conditioner warms up, the fan may not operate for about 3 to 5 minutes at the beginning to prevent cold blasts.
- If the air conditioner heats insufficiently, use an additional heating appliance in combination with the air conditioner.

Automatic defrost

When the outdoor temperature is low and the humidity is high, frost may develop on the outdoor heat exchanger, which may decrease heating efficiency. When these conditions are met while Heat mode is on, the air conditioner runs the Defrost function for 5 to 12 minutes to remove frost from the outdoor heat exchanger.

NOTE

- When the Defrost function is on, the **dF** (Defrost) indicator appears on the indoor unit display, steam is produced on the outdoor unit, the air conditioner moves the airflow blades to the lowest position to prevent cold air from coming out from the indoor unit.
- You cannot select other functions with the remote control until the Defrost function is finished.

Variety Smart Features

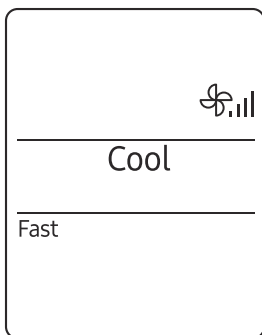

Fast function

Use the Fast function to quickly cool or heat your room. This function is the most powerful cooling and heating function provided by the air conditioner. You can select this function in Cool or Heat mode.

In Cool or Heat mode ▶ 

NOTE

- You can change the airflow direction, but you cannot change the set temperature and the fan speed.
- When you select the Fast function in Heat mode, you may not be able to increase the fan speed for 3 to 5 minutes while the unit heats up.
- Selecting the Fast function cancels the Wind-Free Cooling, Eco, good'sleep, and Quiet functions.
- You can also start the Fast function from the Options menu:

In Cool or Heat mode ▶  ▶   ▶

Select Fast. ▶ 

Variety Smart Features

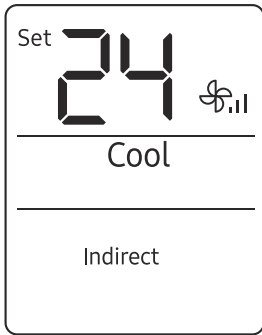
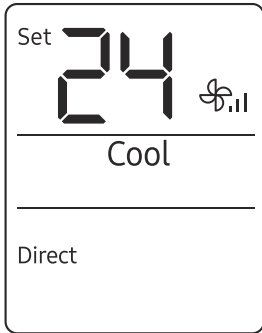

Smart Features

Motion detect function

Use the motion detect function to make the air conditioner detect human motions and blow air directly or indirectly. With no detect, energy-saving mode is operated.

In Cool or Heat mode ▶ ▶ ▶

Select Direct or Indirect. ▶

- When Direct wind is selected
- When Indirect wind is selected

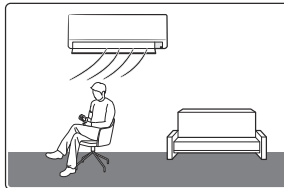

- Wind is sent in the detected direction.

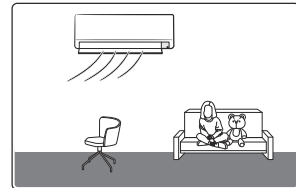

- Wind is sent in the opposite direction of detect.

- When human motions are detected everywhere
- When human motions are not detected

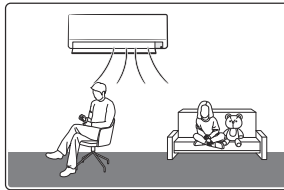

- In case of Direct wind, the air conditioner blows left and right swing airflow. In case of Indirect wind, centre airflow.
- In Heat mode, the vertical airflow blade moves up.

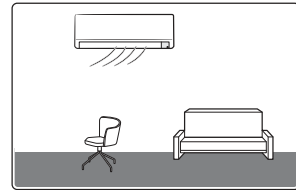

- When no human motions are detected for about 20 minutes, Energy-saving mode starts and the set temperature can change to up to 28 °C.
- When human motions are detected in Energy-saving mode, the previous operation restarts.

**NOTE**

- The motion detect function operates only in Cool and Heat modes.
- The motion detect sensor can detect human motions within 5 m. It may not detect human motions outside the range.
- If any obstacle exists in front of the sensor or the site is subject to direct sunlight or wind, the sensor may not operate properly.
- The motion detect sensor can more easily detect the side to side motions of a person than the back and forth motions.
- The motion detect sensor is located at the bottom right of the product. Therefore, when a person is located around the center of the product, the sensor recognizes that the person is located at the left and the product blows air accordingly.
- Some areas around the center of the sensor may not be detected.
- The motions of a warm-blooded pet, swinging heater, or robot cleaner can be recognized as human motions.
- When a person stops movement within the detectable range, it may not be detected.
- Because the motion detect sensor can recognize movement of heats, it may not operate when a person turns backwards, exposes the skin less or is blocked by obstacles such as laundry.
- The sensor's sensitivity may be lowered depending on the thickness of clothes.
- If you change the current mode, airflow direction, or optional function, the motion detect function is canceled.
- If a person takes body motions in the same place or there is no movement for a long time, it is recognized as an absence.
- If there are little motions such as in cases of infants and patients, or if little motions continue such as in cases of sleeping and movie watching, it can be recognized as an absence.
- Do not place a large object, heating appliance, or humidifier near the product.
- Do not touch the sensor. Failing to do so may result in product damage or malfunction.



Variety Smart Features

Smart Features

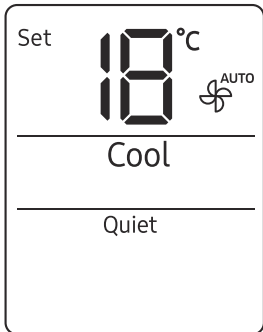

Quiet function

Use the Quiet function to reduce the unit's operating noise. You can select this function in Cool or Heat mode.



NOTE

- You can change the set temperature and the airflow direction, but you cannot change the fan speed.
- Selecting the Quiet function cancels the Wind-Free Cooling, Eco, good'sleep, and Fast functions.

Beep function

Use the Beep function to turn on or off the beep that sounds when you press a button on the remote control.



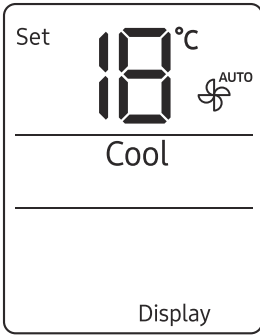

Display lighting function

Use the Display lighting function to turn on or off the lighting of the indoor unit display.



NOTE

- If you change the current mode or function when the Display lighting function is on, the display lighting turns on for 5 seconds and then turns off again.
- To turn off the Display lighting function, run the method above again or turn the product off and on.

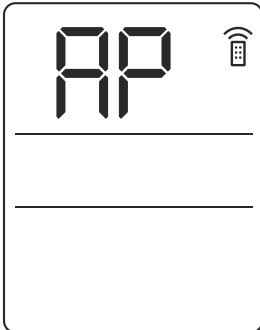

Wi-Fi function (SmartThings app)

Turn on the Wi-Fi function to pair your smartphone with the air conditioner.



NOTE

- When you turn on the Wi-Fi function, your smartphone pairs with the air conditioner, the  (Transmit) indicator blinks, and **AP** appears on the remote control display for a few seconds.
- Once your smartphone is connected with the air conditioner, you can control it via the wireless Internet using the SmartThings app installed on your smartphone.
- For more information about how to prepare your smartphone for connection and how to control the air conditioner using the SmartThings app, see "SmartThings app" on page 39.

Energy-Saving Features

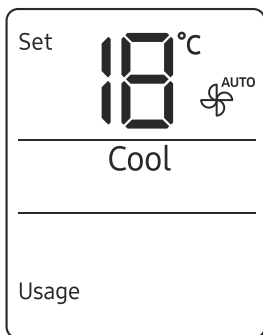

Electricity consumption check

Use the Usage function to check the amount of electricity consumed by using the air conditioner. The amount consumed is displayed on the indoor unit display for a few seconds, and the set temperature appears.

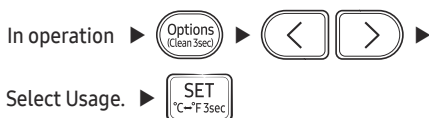

The value range displayed is between 0.1 kWh and 99 kWh. Electricity consumption is calculated from the moment the air conditioner turns on. The value is reset when the air conditioner turns off.

NOTE

- The usage shown on the indoor unit display may slightly differ from the amount of electricity actually consumed.
- You can view electricity consumption only when the air conditioner is operating.

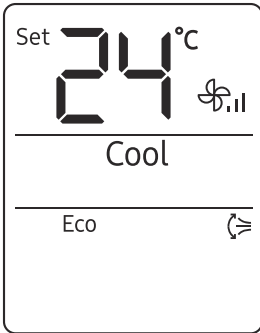

Eco function

Use the Eco function to reduce electricity consumption while staying cool or warm. You can select this function in Cool or Heat mode.

In Cool or Heat mode ▶ ▶ ▶

Select Eco. ▶

NOTE

- When the Eco function starts, the pattern appears on the remote control for a few seconds and vertical air swing begins.
- You can change the set temperature, airflow direction, and fan speed.
- The allowed set temperatures while the Eco function is on are:

Mode	Minumum set temperature	Maximum set temperature
Cool	24 °C	30 °C
Heat	16 °C	30 °C

- If you change the set temperature to be outside the allowed range for the current mode, the set temperature is automatically reset to be within the range.
- When you turn off the Eco function, the air swing continues. Use the (Vertical air swing) or (Horizontal air swing) button to turn it off.
- Selecting the Eco function cancels the Wind-Free Cooling, good'sleep, Fast, and Quiet functions.

Energy-Saving Features

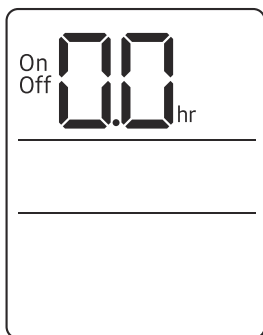

Timed on/ Timed off function

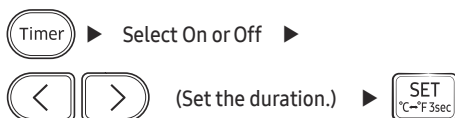

Use the Timed on/off function to turn the air conditioner on or off after a duration. Scheduling durations before the air conditioner turns on or off helps use the air conditioner economically.



NOTE

- To cancel the Timed on/off function, set the duration to 0.0.
- When you start the Timed on/off function, the  (Timer) indicator appears on the indoor unit display.
- You can set the duration to from 0.5 hours to 24 hours.
- You cannot set the same duration for both Timed on and Timed off functions.

Combining Timed on and Timed off

When the air conditioner is off	Example: Timed on 3 hours, Timed off 5 hours The air conditioner turns on 3 hours after the last time you press the  (SET) button to start the Timed on/off function, remains on for 2 hours, then turns off again.
When the air conditioner is on	Example: Timed on 3 hours, Timed off 1 hour The air conditioner turns off 1 hour after the last time you press the  (SET) button to start the Timed on/off function, remains off for 2 hours, then turns on again.

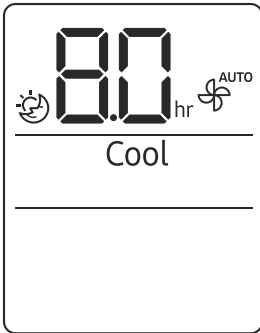

good'sleep function

Use the good'sleep function to save energy while you are sleeping. You can select this function in Cool or Heat mode.

In Cool or Heat mode ▶ (Timer) (Select) ▶

(Set the duration.) ▶ (°C/°F 3sec)

NOTE

- To cancel the good'sleep function, set the duration to 0.0.
- When you start the good'sleep function, the (Timer) indicator appears on the indoor unit display.
- You can set the duration to from 0.5 hours to 12 hours.
- The recommended set temperatures while the good'sleep function is on are:

Mode	Recommended set temperature	Optimal set temperature
Cool	25 °C to 27 °C	26 °C
Heat	21 °C to 23 °C	22 °C

- The good'sleep function can operate while the Wind-Free Cooling function is on.
- Selecting the good'sleep function cancels Eco, Fast, and Quiet functions.

Schedule

Task	How often	By whom	Instruction
Run the Auto clean function.	As needed	Owner	"Auto clean function" on page 31.
Clean the filter.	Once every two weeks	Owner	"Cleaning the filter" on page 34.
Replace the Tri-care filter.	Once every 3 years	Owner	"Replacing the Tri-care filter" on page 35.
Clean the Wind-Free panel	At least once a month	Owner	"Cleaning the Wind-Free panel" on page 36.
Clean the exterior of the indoor unit.	As needed	Owner	"Cleaning the outside of the indoor unit" on page 33.
Clean the exterior of the outdoor unit.	At least once a year	Owner	"Cleaning the heat exchanger on the outdoor unit" on page 33.
Replace the remote control batteries	As needed	Owner	"Replacing the remote control batteries" on page 13.
Apply corrosion inhibitor on outdoor unit. (Only if installed near salt water such as an ocean)	At least once a year	Qualified technician	Contact your service provider.
Clean inside the indoor or outdoor unit.	Once a year	Qualified technician	Contact your service provider.
Inspect the units, electrical connections, refrigerant tubes, and protections.	Once a year	Qualified technician	Contact your service provider.

Cleaning

Auto clean function

Use the Auto clean function if the indoor unit produces odors.

Activating Auto clean

To activate Auto clean, press the  (Options) button for at least 3 seconds.

The indoor unit display shows:



If the air conditioner is off, Auto clean starts immediately. If the air conditioner is running, Auto clean starts as soon as the air conditioner turns off.

NOTE

- You can also activate Auto clean from the Options menu:



- Once Auto clean is selected, it is always activated whenever the air conditioner turns off.
- Auto clean runs for 10 to up to 30 minutes depending on internal dry conditions. The indoor unit display shows the cleaning progress from 1% to 99%.
- If you start another function while Auto clean is progressing, Auto clean pauses and will resume when the other function stops.
- When Auto clean completes, the air conditioner turns off.

Cleaning

Canceling Auto clean

To cancel Auto clean while it is running, follow the procedure below:

 ▶ Press and hold for 3 or more seconds.

OR

 ▶   ▶ Select Clean. ▶ 

NOTE

- Canceling Auto clean does not deactivate it.

Deactivating Auto clean

To deactivate Auto clean, follow the procedure below while the air conditioner is in operation or turned off:

 ▶   ▶ Select Clean. ▶ 

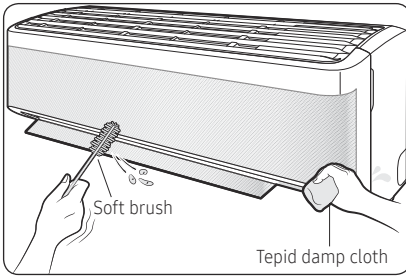

Cleaning the outside of the indoor unit

- 1 Turn off the air conditioner and wait until the fan stops.
- 2 Disconnect the power supply.
- 3 Use a soft brush or tepid damp cloth to clean the exterior.

WARNING

- Do not clean the appliance by spraying water directly onto it. Water entering the unit may result in electric shock or fire that could cause death, serious injury, or property damage:

CAUTION

- Do not use an alkaline detergent to clean the indoor unit display.
- Do not use sulphuric acid, hydrochloric acid, or organic solvents such as paint thinner, kerosene, acetone, benzene, or alcohol to clean the unit surfaces.

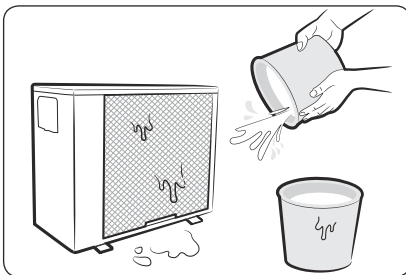

Cleaning the heat exchanger on the outdoor unit

- 1 Turn off the air conditioner and wait until the fan stops.
- 2 Disconnect the power supply.
- 3 Spray water on the heat exchanger to remove dust and other debris.

CAUTION

- Do not use sulphuric acid, hydrochloric acid, or organic solvents such as paint thinner, kerosene, acetone, benzene, or alcohol to clean the unit surfaces.
- If you need to inspect or clean the inside of the heat exchanger on the outdoor unit, contact a local service centre for help.



Cleaning

Cleaning the filter

Clean the air filter every two weeks or when the **F** (filter-cleaning reminder) appears on the indoor unit display. The time between cleanings may vary, depending on the usage and environmental conditions.

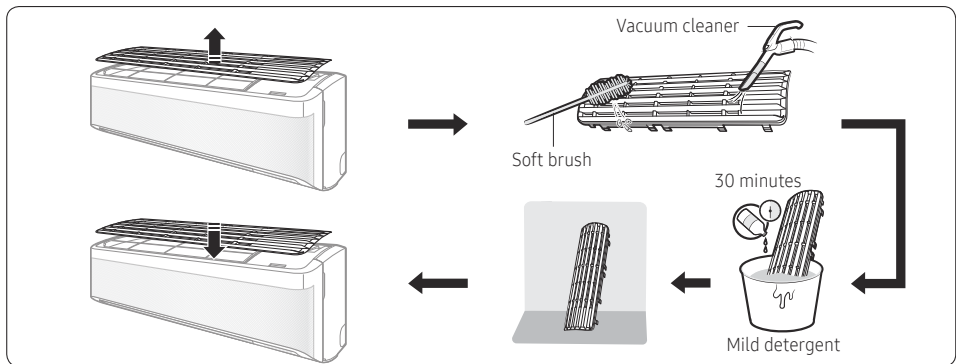

- Slide the filter off of the unit.
- Use a soft brush or vacuum cleaner to remove any dust or debris on the filter.
- Soak the filter in a solution of water and mild detergent for 30 minutes.
- Rinse the filter and let it air dry in a well-ventilated area that is out of direct sunlight.
- Reinstall the filter.
- Reset the filter-cleaning reminder:



⚠ CAUTION

- Take care not to damage the filter during cleaning.
- Do not scrub the air filter with a hard-bristle brush or another cleaning utensil.
- Do not expose the air filter to direct sunlight when drying it.

Replacing the Tri-care filter

Slide a new Tri-care filter in the direction of arrow 2.

Replace Tri-care filters once every three years. Replacement cycle may differ depending on the environment and usage time.

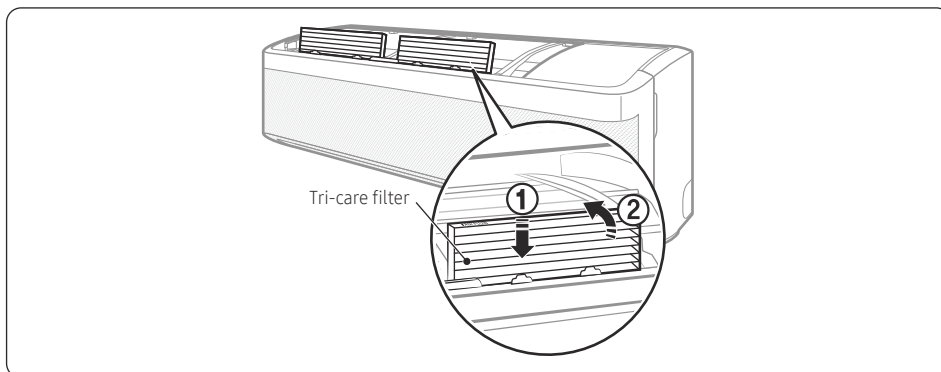

CAUTION

- Do not clean the Tri-care filter with water. Failing to do so may result in damage to the filter.

NOTE

- To replace a Tri-care filter, purchase a new one at a service centre.
- To use the Tri-care filter for a long time in an environment where fish cooking and smoking cause odour, ventilate the place by opening a window.

Cleaning

Cleaning the Wind-Free panel

Clean the Wind-Free panel at least once a month.

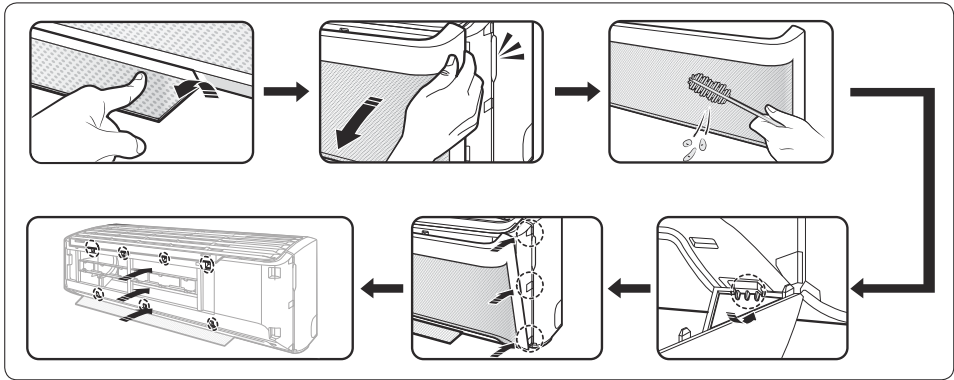

- 1 Pull the airflow blade open.
- 2 Hold and pull both sides of the Wind-Free panel until it comes free from the air conditioner.
- 3 Use a soft brush or vacuum cleaner to remove any dust.
- 4 Hang the Wind-Free panel in the grooves at the bottom left and right.
- 5 Align the projections of the Wind-Free panel with the grooves at the top, middle, and bottom of the front panel.
- 6 After inserting the Wind-Free panel, press the top 4 places and the bottom 3 places by hand so that there is no gap to the panel.

CAUTION



- If you attach the Wind-Free panel without the airflow blade being open, it may become obstructed by the Wind-Free panel and may not open properly.

Troubleshooting

If the air conditioner is not operating normally, refer to the troubleshooting guide below.

Problem	Solution
The air conditioner stops working.	<ul style="list-style-type: none"> • Make sure the unit is receiving power. • Check the circuit breaker. If it is flipped off, flip it on again and restart the unit. If the problem persists, contact your service provider. • The Timed off function may have turned off the unit. Turn on the unit again.
Cannot change the temperature.	<ul style="list-style-type: none"> • Check if the unit is in Fan or Fast mode. If so, you cannot change the set temperature; the unit automatically controls the set temperature.
Improper airflow temperature.	<ul style="list-style-type: none"> • Check the set temperature. In Cool mode, cooling occurs only when the set temperature is lower than the current temperature. In Heat mode, heating occurs only when the set temperature is higher than the current temperature. • Use the  (Temperature) button on the remote control to change the set temperature. • Check if the air filter is blocked with dirt or debris. If the air filter is blocked, the cooling and heating performance may decrease. Clean the air filter regularly (page 34). • Check if the outdoor unit is covered or is installed near obstacles. Remove the coverings and obstacles. • Check if the Defrost function is on (page 20). During defrost, the fan stops and warm air does not come out. • Check if doors or windows are open. This may cause poor circulation or performance. Close all doors and windows. • Check if the pipe length between the units exceeds the maximum pipe length (see "Typical installation" in the Installation manual). If so, the cooling and heating performance may decrease.
Cannot change the airflow direction.	<ul style="list-style-type: none"> • Check if the good'sleep function is on in Cool mode. If so, you cannot control the airflow direction.
Cannot change the fan speed.	<ul style="list-style-type: none"> • Check if the unit is in Auto, Dry, or Fast mode or the good'sleep function is on in Cool mode. In these conditions, you cannot control the fan speed; the unit automatically controls the fan speed.

Troubleshooting

Problem	Solution
The remote control does not work.	<ul style="list-style-type: none"> Replace the batteries in the remote control. Make sure the remote control can send an unobstructed signal to the unit. Keep bright lights away from the unit. Light from fluorescent bulbs or neon signs may interrupt the signal from the remote control.
The Timed on/off function does not work.	<ul style="list-style-type: none"> Make sure to press the  (SET) button on the remote control when setting the timer.
The indicator on the remote control blinks continuously.	<ul style="list-style-type: none"> Press the  (Power) button to turn off the unit, or disconnect the power plug. If the indicator light on the remote control continues blinking, contact your service provider.
Odors are coming from the unit during regular operation.	<ul style="list-style-type: none"> If the unit is operating in a smoky area, ventilate the room or operate the unit in Fan mode for 3 to 4 hours. There are no components in the unit that produce a strong odor. Check if the drain lines are clean. Clean them regularly.
The remote control display shows an error message.	<ul style="list-style-type: none"> If the indoor unit indicator blinks, write down the error code. Contact your service provider and provide them with the error code.
The unit is generating noise.	<ul style="list-style-type: none"> It is normal for the unit to generate some noise while operating. If the pipe length between the units is less than 3 m and no coil was used (see "Typical installation" in the Installation manual), additional noise may be transmitted from the outdoor unit to the indoor unit via the piping.
Smoke is coming from the outdoor unit.	<ul style="list-style-type: none"> In winter, most likely this is steam coming from the outdoor heat exchanger while the Defrost function is on.
Water drips from the pipe connections on the outdoor unit.	<ul style="list-style-type: none"> Condensation may develop when the ambient temperature or humidity changes significantly. This is normal.

SmartThings app

The SmartThings app may change without prior notice to improve product usability and performance. Use the SmartThings app on your smartphone to control the air conditioner via the wireless Internet. To remotely control the air conditioner, you need to connect your smartphone to the air conditioner. If already connected, skip to "Step 6. Controlling the air conditioner with your smartphone" on page 40.

Step 1. Checking the requirements for connection

Before connecting your smartphone with the air conditioner, make sure that the following requirements are met:

- Wi-Fi access point: 2.4 GHz Wi-Fi access point only
- The air conditioner and your smartphone must be within the coverage of the same Wi-Fi access point and connected to it. After the connection, you can control the air conditioner from any place via various wireless networks such as Wi-Fi, 3G, LTE and 5G.
- Recommended Android phones: Android 6.0 or later, at least 2 GB RAM
- Supported Apple phones: iOS 10.0 or later, iPhone 6 or later
- Android tablets and iPads are not supported.

Step 2. Connecting your smartphone to the Wi-Fi network

- 1 Turn on the Wi-Fi access point.
- 2 Tap **Settings** → **Wi-Fi** on your smartphone.
- 3 Tap the **Wi-Fi** switch to activate it, and then select the 2.4 GHz Wi-Fi access point to connect to.
- 4 If needed, enter the password for the access point.
- 5 Tap **Advanced**.
- 6 Top the **Switch to mobile data** switch to deactivate it.

Step 3. Installing the SmartThings app

If the SmartThings app is not installed on your smartphone, follow the procedure below. If installed, skip to "Step 4. Configuring the SmartThings app" on page 39.

- 1 Launch **Play Store** or **App Store**.
- 2 Tap the search field, and then search for "SmartThings".
- 3 Tap **INSTALL** for the found SmartThings app item.
- 4 Select **Agree**.

Step 4. Configuring the SmartThings app



After the SmartThings app is installed, follow the procedure below to configure it. If already configured, skip to "Step 5. Connecting your smartphone to the air conditioner" on page 40.

- 1 Launch the **SmartThings** app.
- 2 When you see pop-up windows asking for location, Wi-Fi, Bluetooth permissions, tap **Start**.
- 3 Tap **Log In**.
- 4 If you have no Samsung account, tap **Add account** to create your Samsung account.
- 5 Log in to your Samsung account.
- 6 Consent to **TERMS AND CONDITIONS**.
- 7 When you see a pop-up window asking for access permission to location information, tap **ALLOW**.

SmartThings app

Step 5. Connecting your smartphone to the air conditioner

- 1 Plug in the power cord of the air conditioner, and then turn on the power.
- 2 Launch the **SmartThings** app.
- 3 Tap **Add device** on the home screen of the SmartThings app.
- 4 Tap **ADD DEVICE MANUALLY**.
- 5 Tap **Air conditioner** > **Room air conditioner**.
- 6 Press the  (Timer) button on the remote control for at least 4 seconds.

To notify that registration of the selected air conditioner to your Samsung account is in progress, the  (Transmit) indicator blinks for several seconds and **RP** appears on the remote control display. When the connection is finished, the  (Transmit) indicator turns off and **RP** disappears. A new device card for the selected air conditioner is added to the home screen of the SmartThings app.

Step 6. Controlling the air conditioner with your smartphone

- 1 Launch the **SmartThings** app.
- 2 On the home screen of the SmartThings app, tap the device card for the air conditioner, which was added when you proceeded with "Step 5. Connecting your smartphone to the air conditioner" on page 40.
- 3 Refer to the table on the next page and remotely control the air conditioner with your smartphone.



WARNING

- RF exposure warning statement – for keeping 20cm distance when installing this module.
- Warning that this module should not be installed and operating simultaneously with other radio without additional evaluation or FCC filing.

- Instruction for host system labeling, the host system should have proper label showing that it "Contains FCC ID : A3LSWL-B70F"
- Your device uses non-harmonised frequency and is intended for use in all European countries. The WLAN can be operated in the EU without restriction indoors, but cannot be operated outdoors in France.

Specifications

Frequency Range	Transmitter Power(Max)
2412 - 2472 MHz	20 dBm

Open Source Announcement

The software included in this product contains open source software. You may obtain the complete corresponding source code for a period of three years after the last shipment of this product by sending an email to mailto:oss.request@samsung.com.

It is also possible to obtain the complete corresponding source code in a physical medium such as a CD-ROM; a minimal charge will be required.

The following URL http://opensource.samsung.com/opensource/SMART_AT_051/seq/0 leads to the download page of the source code made available and open source license information as related to this product. This offer is valid to anyone in receipt of this information.



Category	Function	Description
Monitoring	Set temperature	Displays the set temperature.
	Current temperature	Displays the current temperature.
Control	Power	Turns the air conditioner on or off.
	Mode	Selects the desired operation.
	Temperature	Adjusts the indoor set temperature.
	Fan Speed	Sets the fan speed of operation mode.
	Wind direction	Sets the fan directions of operation mode.
	Wind-Free Cooling	Turns the Wind-Free Cooling function on or off.
	Schedule	<p>Sets the Timed on/off function.</p> <ul style="list-style-type: none"> The maximum number of schedules you can set using the Timed on/off function is 10. The set times for the Timed on and Timed off functions must be different. Once the Timed on/off function is set, the setting remains even if you unplug the air conditioner and plug in it again.
	Options	<p>Selects an option function of operation mode.</p> <ul style="list-style-type: none"> The available options might be different depending on the air conditioner model. The fan speed and airflow direction are set automatically according to the selected options. For detailed information on the options of the product, see page 16 ~ 25.
Settings	<p>Sets additional functions.</p> <ul style="list-style-type: none"> Press the Settings button on the control screen to check or set detailed information of air conditioner. The functions of Clean, Filter, and Beep can be set. <ul style="list-style-type: none"> When the Beep function is off, the beep sound from the device will be mute. 	



SAMSUNG

QUESTIONS OR COMMENTS?

COUNTRY	CALL	OR VISIT US ONLINE AT
ISRAEL	*6963	www.samsung.com/il/support/